

# S

## SERIES



SVEBA DAHLEN



SR120



SRP120



SRD120



SR2D120



SR120DS



SRDP120



# THE KING OF O

When the focus is on flexibility



P120

SR130

SRP130

SRD130

SR240

SRP240



# COMBINATIONS

and optimum baking results

# RACK OVEN

SVEBA DAHLEN



## Airflow

A horizontal airflow developed to give a very even baking result across the rack, even for delicate bakes with short baking times. The airflow also affords better efficiency and consequently lower heating costs.



## Rotation

Rotating rack with optimized rotation speed and automatic change of rack rotation direction, which gives a more even bake and better results.



## Steam system

A uniquely developed steam system with both even and efficient capacity, as well as rapid recovery, resulting in a greater production capacity.



## Control panel

A user-friendly, smart control panel that gives the user complete control of the entire baking process.



# PROPERTIES AND FUNCTIONALITY

## RACK OVEN

Even and efficient baking at all times! The S-Series is a compact, energy-efficient combination oven and mini rack oven with an industrial feel, adapted to the needs of a supermarket bakery or smaller-volume bakery. Available in three sizes: SR120, SR130 and SR240. The oven is also available as a double mini rack oven, the SR120DS, which allows you to bake two completely different end products with different settings at the same time. The oven is available in stainless steel and in black (option).

### 1. Flexible baking with baking results similar to an industrial rack oven

Made from sturdy materials and tried-and-tested, premium components to guarantee optimum baking results from a limited space. Optimized airflow, rack rotation, as well as smart built-in functions and a professional steam system. Bakes everything from delicate biscuits to larger pastries, rolls and macaroons. Frequency converters (option) for variable fan speed are helpful when baking sensitive products such as meringues, macaroons and muffins. Space for six or ten trays in a standard rack. Maximum baking temperature 300°C.

### 2. Increased Baking Surface (IBS)

A patented system for alternate rack rotation inside the oven. The IBS system provides faster, more even and more energy-efficient baking.

### 3. Integrated, programable, high-capacity steam system

Settings for how much steam is released and when it should be turned on and off. Gives a smooth, crisp crust and for some breads a significantly increased volume.

### 4. SD Touch II - smart digital control panel

A user-friendly, smart control panel that gives the user complete control of the entire baking process. Weekly schedule, record recipes and much more. Comes with 11 pre-programmed recipes that can be used as a basis for new recipes.

### 5. Energy-efficient

The components and features are customized to offer the lowest cost for baking. To save energy, the control panel offers a power-saving mode that turns off the lights and closes the damper, and it is possible to regulate the fan speed to low with a frequency converter (option).

### 6. Steam-free working environment

The canopy effectively catches heat and steam when the oven door is opened. The condensation unit (option) effectively removes steam and moisture in the oven, which means an improved working environment.

### 7. Robust, removable design gives a long service life

Made of sturdy, stainless steel that is easy to keep clean. Two lockable castors allow easy handling and movement, for example during cleaning.

### 8. Heat-reflecting oven window

The door is fitted with a large heat-reflecting double glazed window. Efficient halogen light illuminates the oven compartment and gives the baker a clear overview of the baking process. This therefore tempts customers to buy products in store when they see the tasty pastries rotating inside the oven.

# DECK OVEN



## Heating system

Turbo function, double temperature sensors and high-quality heating elements for even temperature distribution.



## Energy efficiency

Fully insulated walls, floors and tops keep the heat inside the oven. The heat sources are installed inside the oven compartment and are powered by direct electricity, which means eco-friendly energy use.



## Stone-baked bread

Thoroughly tested stone hearth. Built-in steam function for optimum baking results when it comes to stone-baked bread.

# PROPERTIES AND FUNCTIONALITY

## DECK OVEN

Perfect stone-baked bread! The S-Series deck oven is available in combinations with rack oven, double deck oven and proofer underneath. Together, these form a complete combination oven with maximum flexibility and fantastic baking opportunities in a small space.

### 1. Flexible baking

The oven is supplied with both a stone sole and a hearth grid, for baking on trays as standard. This makes it possible to bake a wide range of products and pastries, including sourdough bread, ciabatta, buns and pizza. With the combination of a mini rack oven, deck oven and proofer, the bakery's flexibility will be hard to beat.

### 2. Efficient heating system

High-quality door gasket and well-insulated oven compartment that retains heat in a more efficient manner. Reliable heating elements with turbo function that quickly and efficiently bring the oven up to the right temperature. Double temperature sensors, placed above and below the stone for an even, accurate temperature. Maximum baking temperature 280°C.

### 3. Integrated, programable, high-capacity steam system

Settings for how much steam is released and when it should be turned on and off. Gives a smooth, crisp crust and for some breads a significantly increased volume.

### 4. SD Touch II - smart digital control panel

A user-friendly, smart control panel that gives the user complete control of the entire baking process. Individual panels for rack oven and deck oven.

### 5. Energy-efficient

The components and features are customized to offer the lowest cost for baking. To save energy, the control panel offers a power-saving mode that turns off the lights, closes the damper and regulates the heat sources.

### 6. Effective lighting

Halogen lights provide the oven with a more concentrated working light that illuminates the oven compartment and gives the baker a clear overview of the baking process.

### 7. Smart door design

The oven door opens easily with the aid of a handle that remains cool. The door opens upwards and inwards, minimizing the risk of burns.

### 8. Large oven window

The door is fitted with a large oven window, providing the baker with a clear overview of the baking process.

### 9. Quick and easy cleaning

The smart design of the door makes cleaning easier. The oven is also equipped with a removable crumb tray, which can easily be removed and emptied during cleaning.

# UNDERBUILT PROOFER



## Energy efficiency

High energy efficiency thanks to intelligent energy-saving features and a well-insulated proofer.



## Temperature and humidity

Temperature and humidity are set separately. Ensures optimal control for proofing.

1

6

5

7

2

3

4



## PROPERTIES AND FUNCTIONALITY

### UNDERBUILT PROOFER

Fresh bread in the store or bakery at all times! With the combination of rack oven and proofer, the bakery gains a smooth and space-efficient complete solution where the baker can allow the products to proof and bake as needed. The proofer is equipped with an automatic water feed as well as humidity and temperature sensors.

#### 1. Digital control panel

User-friendly control panel with functions for temperature and humidity settings and timer.

#### 2. Optimal proofing

Fitted with EHDS - Effective Humidity Distribution System, which generates optimal distribution of steam in the proofer. The cabinet also has an automatic water feed, temperature and humidity sensors as well as an optimized circulation fan.

#### 3. Flexible proofing

The proofing is adjusted using the temperature and humidity settings in the control panel. Easy adjustment of guides to fit the desired tray size. Space for up to 10 baking trays. Proofing temperature: from ambient temperature to +60°C.

#### 4. Good overview of the proofing process

Large window in the door and vertical LED strip inside the cabinet gives a clear view of the entire proofing process on all the trays, without needing to open the door.

#### 5. Robust construction

Made from stainless steel and high quality materials, ensuring a long service life. Drainage in proofer to lead away condensation. Stable doors that are easy to open and close. Robust castors, two of which are lockable.

#### 6. Energy-efficient

The cabinet maintains an even, stable temperature and preserves heat inside the proofing area.

#### 7. Easy cleaning

The proofer is made from stainless steel and has a jointless floor. The guides can easily be removed for simple cleaning of the proofer. The guides can be cleaned in a dishwasher. The control panel has a glass screen that can easily be wiped down.

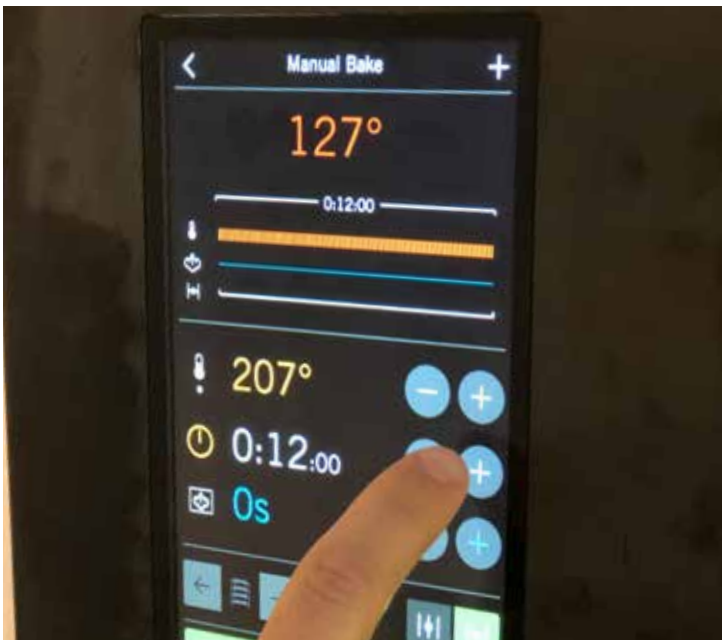

## SD Touch II - new generation of smart control panels

Time-saving, energy-efficient baking plus smart baking functions with the SD Touch II. The panel makes everyday baking easier and helps the baker get the best possible results. Time-saving features such as programmable weekly schedules and recipe management, with precision to the second in baking times, heat settings and steam supply. Baking settings are so simple that anyone can get started with a bake. User-friendly touch panel with clear interface, high definition display, sharp contrast and swipe function. Can be connected to the Sveba Connect cloud service, but also has features for reading the energy consumption directly from the panel.

### PROPERTIES AND FUNCTIONALITY

#### Connect to the cloud - Sveba Connect, rack oven

- Update the panel's software with a single click.
- Service information, statistics and overview of all connected ovens in real time.
- Upload, download and share recipes.

#### Half-rack function, rack oven

- Adjust the saved recipe's temperature, steam, baking time and damper time to suit partially filled oven racks.

#### Preprogrammed recipes, rack oven

- The rack oven comes with 11 preprogrammed recipes.
- The preprogrammed recipes are based on general weights and products and not details about raw materials and type.
- The recipes available are: Loaf 500 g, loaf 800 g, muffin 60 g, roll with steam 70 g, soft roll 70 g, sweet dough pastry 300 g, toast bread 1200 g, baguette 300 g, cinnamon roll 80 g, croissant 70 g, Danish 80 g.

#### Modern touch screen

- Vertical swipe function.
- High resolution screen.

#### Recipe management

- Save recipe.
- Exact timings to the minute and second for baking time, temperature, steam, etc.
- Add recipes to Favorites for quick access.

#### Easy cleaning

- Dust and moisture-resistant panel.
- Frameless display at the level of the baking tray.

#### Programmable weekly schedule

- The oven is pre-heated by the start of the working day.
- Prepare work for the week.
- Set the desired oven temperature and the start/end times.

#### Statistics and graphs

- Energy and cost graphs shown directly in the panel.
- Track user statistics from several years ago up to the present day.



## Check the proofing process - user-friendly digital control panel

The S-Series' underbuilt proofers have a well-thought-out design that, together with smart functions and a user-friendly control panel, entails reliable operation and a stable temperature inside the cabinet. The proofer's control panel allows the user to easily set the temperature and humidity individually, giving total control over the proofing process and ensuring optimal proofing in a small space!

## PROPERTIES AND FUNCTIONALITY

### Temperature

- See the current temperature inside the cabinet.
- Enter the desired proofing temperature.
- Adjust the temperature depending on the dough type.

### Humidity

- See the current humidity inside the cabinet.
- Enter the desired humidity.
- Adjust the humidity depending on the dough type.

### Timer

- Enter the desired proofing time.
- Audio signal sounds when the proofing program is complete.

### Easy cleaning

- Glass screen.
- Dust and moisture-resistant panel.
- Frameless display.

### Audio signal

- Audio signal when the program is complete.
- Audio signal in the event of any fault codes.

## TECHNICAL SPECIFICATIONS



		SR120	SR120DS	SRD120	SR2D120
<b>COMBINATION OVEN</b>	Modules included in the combination	Rack oven	2 x rack oven	Rack oven, deck oven	Rack oven, 2 x deck oven
	Outer dimensions with canopy etc. W x D <sup>1</sup> x H [mm]	990 x 1243 <sup>1</sup> x 2074 mm	990 x 1243 <sup>1</sup> x 2245 mm	990 x 1243 <sup>1</sup> x 2290 mm	990 x 1243 <sup>1</sup> x 2229 mm
	Power, total [kW]	14.3 kW	28.6 kW	19.8 kW	25.3 kW
	Average consumption, total [kW/h] **	8.6 kW/h	17.2 kW/h	11.9 kW/h	15.2 kW/h
	Weight, total [kg]	250 kg	490 kg	370 kg	490 kg
<b>MINI RACK OVEN</b>	Maximum baking temperature, rack oven	300°C	2 x 300°C	300°C	300°C
	Max. tray dimensions, rack oven [mm]*	600 x 400	600 x 400	600 x 400	600 x 400
	Max. diagonal tray Ø mm*	-	-	-	-
	Max. no of trays, rack oven, 600 x 400 mm	6 pcs	2 x 6 pcs	6 pcs	6 pcs
	Max. no of trays, rack oven, 600 x 450 mm	-	-	-	-
	Minimum feed height, tray, rack oven [mm]	1133 mm	409 mm	1349 mm	1288 mm
	Maximum feed height, tray, rack oven [mm]	1493 mm	1664 mm	1709 mm	1648 mm
	Max. dough weight, rack oven [kg]	25 kg	2 x 25 kg	25 kg	25 kg
	Door swing radius, rack oven [mm]	585 mm	585 mm	585 mm	585 mm
	Recommended fuse, rack oven [amp]	25 A	2 x 25 A	25 A	25 A
	Power, rack oven [kW]	14.3 kW	2 x 14.3 kW	14.3 kW	14.3 kW
	Average consumption, rack oven [kW] **	8.6 kW/h	2 x 8.6 kW/h	8.6 kW/h	8.6 kW/h
<b>DECK OVEN</b>	Max. baking temperature, deck oven	-	-	280°C	2 x 280°C
	Max. tray dimensions, deck oven [mm]	-	-	600 x 400 mm	600 x 400 mm
	Max. no. of trays, deck oven, 600 x 400 mm	-	-	1 pcs	2 x 1 pcs
	Baking area, stone sole, deck oven [mm]	-	-	630 x 450 mm	2 x 630 x 450 mm
	Recommended fuse [amp]	-	-	16 A	2 x 16 A
	Power, deck oven [kW]	-	-	5.5 kW***	2 x 5.5 kW***
	Average consumption, deck oven [kW] **	-	-	3.3 kW/h	2 x 3.3 kW/h
<b>UNDERBUILT PROOFER</b>	Max temperature, underbuilt proofer	-	-	-	-
	Recommended fuse [amp]	-	-	-	-
	Power, underbuilt proofer [kW]	-	-	-	-
	Average consumption, underbuilt proofer [kW] **	-	-	-	-
	Max tray size, underbuilt proofer [mm]	-	-	-	-
	Max. no of trays 400 x 600 mm, underbuilt proofer	-	-	-	-
	Door swing radius, underbuilt proofer [mm]	-	-	-	-

<sup>1</sup> Depth without canopy and outfeeds on the back: 953 mm.

\* For exact tray dimensions: sveba.com or check the user manual.

\*\* For continuous baking. Approx. 60% of installed power.

\*\*\* 5.9 kW (3x415V + N).

**SRP120****SRDP120****SR130****SRD130****SRP130****SR240****SRP240**

Rack oven, proofer	Rack oven, deck oven, proofer	Rack oven	Rack oven, deck oven	Rack oven, proofer	Rack oven	Rack oven, proofer
990 x 1243 <sup>1</sup> x 2074 mm	990 x 1243 <sup>1</sup> x 2220 mm	990 x 1164 <sup>1</sup> x 2245 mm	990 x 1243 <sup>1</sup> x 2254 mm	990 x 1213 <sup>1</sup> x 2245 mm	1168 x 1164 <sup>1</sup> x 2245 mm	1168 x 1213 <sup>1</sup> x 2245 mm
15.7 kW	21.2 kW	21.2 kW	26.7 kW	22.6 kW	21.2 kW	22.6 kW
9.4 kW/h	12.7 kW/h	12.7 kW/h	16.0 kW/h	13.6 kW/h	12.7 kW/h	13.6 kW/h
380 kg	500 kg	370 kg	490 kg	500 kg	380 kg	520 kg

300°C	300°C	300°C	300°C	300°C	300°C	300°C
600 x 400	600 x 400	600 x 400	600 x 400	600 x 400	700 x 470	700 x 470
-	-	-	-	-	806 mm	806 mm
6 pcs	10 pcs	10 pcs	10 pcs	10 pcs	10 pcs	10 pcs
-	-	-	-	-	10 pcs	10 pcs
1133 mm	1279 mm	935 mm	944 mm	935 mm	935 mm	935 mm
1493 mm	1639 mm	1691 mm	1700 mm	1691 mm	1691 mm	1691 mm
25 kg	25 kg	40 kg	40 kg	40 kg	40 kg	40 kg
585 mm	585 mm	585 mm	585 mm	585 mm	765 mm	765 mm
25 A	25 A	32 A	32 A	32 A	32 A	32 A
14.3 kW	14.3 kW	21.2 kW	21.2 kW	21.2 kW	21.2 kW	21.2 kW
8.6 kW/h	8.6 kW/h	12.7 kW/h	12.7 kW/h	12.7 kW/h	12.7 kW/h	12.7 kW/h

-	280°C	-	280°C	-	-	-
-	600 x 400 mm	-	600 x 400 mm	-	-	-
-	1 pcs	-	1 pcs	-	-	-
-	630 x 450 mm	-	630 x 450 mm	-	-	-
-	16 A	-	16 A	-	-	-
-	5.5 kW***	-	5.5 kW***	-	-	-
-	3.3 kW/h	-	3.3 kW/h	-	-	-

60°C	60°C	-	-	60°C	-	60°C
10 A	10 A	-	-	10 A	-	10 A
1.4 kW	1.4 kW	-	-	1.4 kW	-	1.4 kW
0.84 kW	0.84 kW	-	-	0.84 kW	-	0.84 kW
600 x 800 mm	600 x 800 mm	-	-	600 x 800 mm	-	700 x 470 mm
10 pcs	10 pcs	-	-	10 pcs	-	10 pcs
737 mm	737 mm	-	-	737 mm	-	623 mm

<sup>1</sup> Depth without canopy and outfeeds on the back: 953 mm.

\* For exact tray dimensions: sveba-dahlen.se or check the user manual.

\*\* For continuous baking. Approx. 60% of installed power.

\*\*\* 5.9 kW (3x415V + N).

## DRAWINGS AND DIMENSIONS [MM]

**SR120**

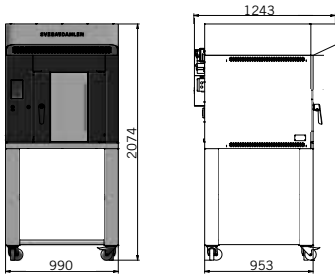

**SRP120**

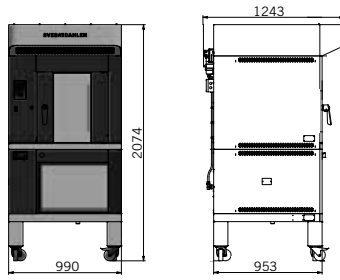

**SR120DS**

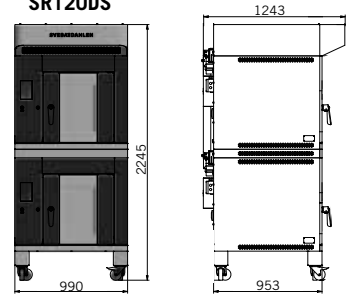

**SRD120**

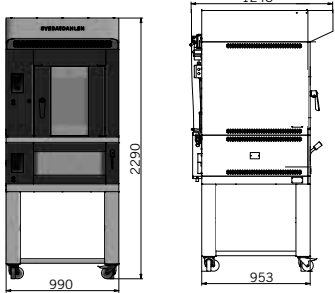

**SRD120**

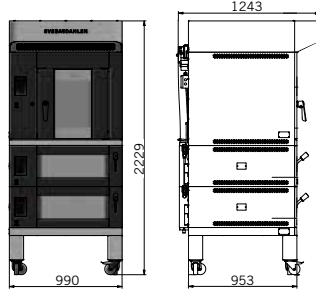

**SRDP120**

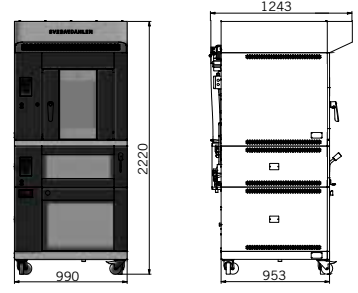

**SR130**

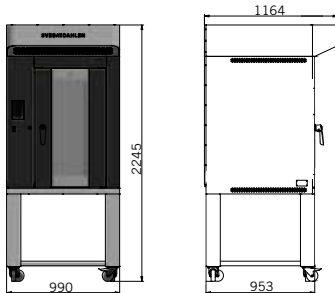

**SRP130**

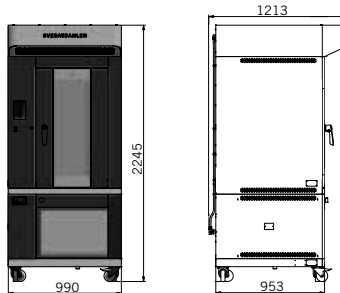

**SRD130**

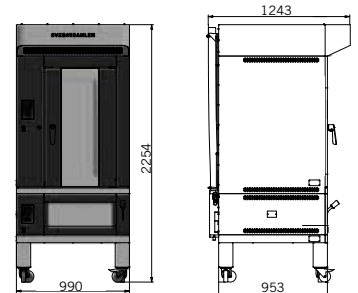

**SR240**

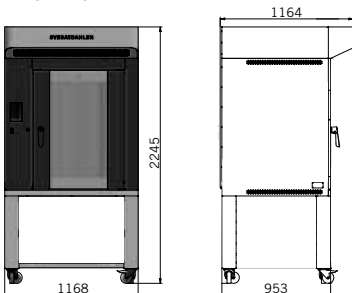

**SRP240**

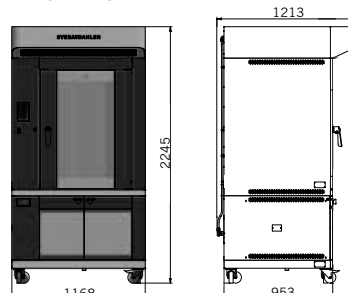

### SR120 oven rack

Rack for 6 baking trays as standard.

No. of trays	Vertical distance between the guides
6	72 mm
5	86 mm
4	105 mm

### SR130 oven rack

Rack for 10 baking trays as standard.

No. of trays	Vertical distance between the guides
10	84 mm
8	104 mm
6	139 mm

### SR240 oven rack

Rack for 10 baking trays as standard.

No. of trays	Vertical distance between the guides
10	84 mm
8	104 mm
6	139 mm

It is possible to pass through a normal doorway with some parts removed.  
(NOTE! Min. measurement for doorway: 895 mm required). For complete instructions, see the manual.

## OPTIONS – S-SERIES

### 1. Canopy with fan

Draws off heat, smells and steam when the oven door is opened (not in combination with condensation unit).

### 2. Condensation unit

Air-cooled condensation unit that captures and converts steam into water before it can spread through the premises. An ideal option in situations where you cannot connect to a ventilation system. Suitable for all S-Series ovens and is easy to maintain and install. Made of stainless steel. Weight: 48 kg. Consumption: 85 W, airflow m<sup>3</sup>/h: 320, max. condensed water l/h: 5. (Not in combination with canopy with built-in fan.)

### 3. Frequency converter for fans - variable speed

The fan speed is driven by a frequency converter to maintain the desired flow of air. This is helpful when baking sensitive products such as meringues, macarons and muffins.

### 4. Automatic rotation stop

The rack automatically rotates to the correct position when the door is opened.

### 5. Extra oven rack for 4, 5 or 6 trays

Fits SR120. Rack for 6 trays supplied with the oven. Guide width 25 or 50 mm. Distance between trays: 6 trays = 72 mm, 5 trays = 86 mm, 4 trays = 105 mm.

### 6. Extra oven rack for 6, 8 or 10 trays

Fits SR130 and SR240. Rack for 10 trays supplied with the oven. Guide width 25 or 50 mm. Distance between trays: 10 trays = 84 mm, 8 trays = 104 mm, 6 trays = 139 mm.

### 7. Sveba Connect - cloud service solution for rack ovens

Access statistics and take control of the energy consumption for connected ovens, recipe management, service information and important notifications. Overview of all connected ovens in real time.

Dimensional sketch SR120 with extra storage shelf.

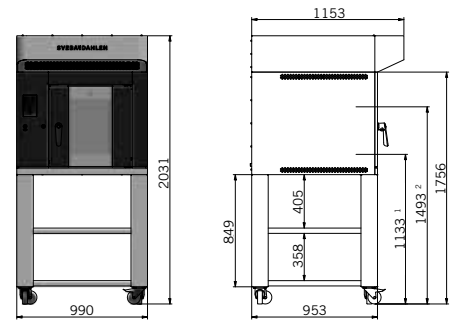

Dimensional sketch SR240 with underbuilt tray rack.

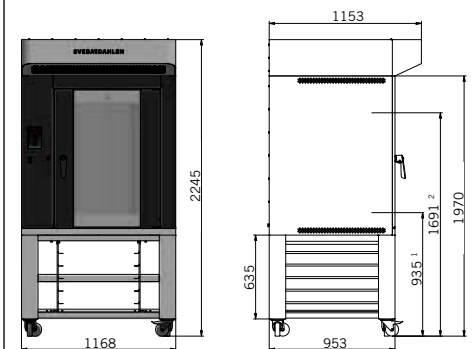

<sup>1</sup> Lowest baking tray infeed.  
<sup>2</sup> Highest baking tray infeed.

	SR120	SRP120	SRD120	SR2D120	SR120DS	SRDP120	SR130	SRP130	SRD130	SR240	SRP240
Left-hand hinged door with double-glazed window *	○	○	○	○	○	○	○	○	○	○	○
Three-glazed door, left or right-hand hinged *	○	○	○	○	○	○	○	○	○	○	○
Canopy with fan (not available with condensation unit) *	○	○	○	○	○	○	○	○	○	○	○
Condensation unit (not available with canopy with fan) *	○	○	○	○	○	○	○	○	○	○	○
Frequency converter for fans - variable speed *	○	○	○	○	○	○	○	○	○	○	○
Automatic rotation stop *	○	○	○	○	○	○	○	○	○	○	○
Extra storage shelf, stainless steel (not with underbuilt tray rack).	○		○				○			○	
Underbuilt tray rack for 10 trays. Adjustable regarding tray size. (12 trays for SR120). Not with extra shelf (trays not included).	○		○				○			○	
Extra oven rack for 4, 5 or 6 trays. Guide width 25 or 50 mm.	○	○	○	○	○	○					
Extra oven rack for 6, 8 or 10 trays. Guide width 25 or 50 mm.							○	○	○	○	○
Black design	○	○	○	○	○	○	○	○	○	○	○
Sveba Connect – Cloud service solution *	○	○	○	○	○	○	○	○	○	○	○
Fully assembled **	●	○	○	○	○	○	●	○	○	●	○

\* For rack oven.

\*\* Canopy, legs and castors are delivered separately (not mounted). [www.sveba.com](http://www.sveba.com)

● Standard ○ Options

**We always provide high-performance, energy efficient and user-friendly equipment.**

We offer reliable technology that gives professionals in the bakery industry their creative freedom at the lowest cost of ownership.

We are the professional business partner throughout the entire baking process, with an accessible organization, user-friendly design and precisely regulated, reliable equipment.

**Sveba Dahlen AB**

Industrivägen 8

SE-513 82 Fristad, SWEDEN

[www.sveba.com](http://www.sveba.com)

[info@sveba.com](mailto:info@sveba.com)

