

CVPE-9-10-RR  
CVPE-9-13-RR  
CVPE-9-15-RR  
CVPE-9-20-RR  
CVPE-9-25-RR  
CVPE-9-30-RR

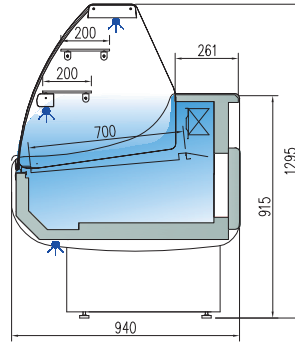

CVPE-9-10-C  
CVPE-9-13-C  
CVPE-9-15-C  
CVPE-9-20-C  
CVPE-9-25-C  
CVPE-9-30-C

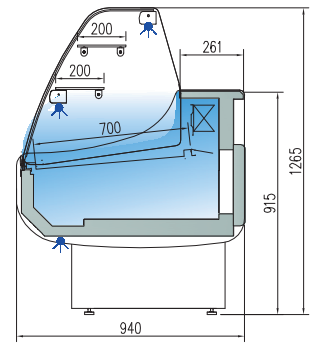

CVPE-9-10-CC  
CVPE-9-13-CC  
CVPE-9-15-CC  
CVPE-9-20-CC  
CVPE-9-25-CC  
CVPE-9-30-CC

mod.	largo length (mm)	exposición display RSA (m <sup>2</sup> )	cámara storage (m <sup>3</sup> )	puertas doors (uds)	potencia frig. frig. power (W)	consumo consumption (W)	refrigerante refrigerant
CVPE-9-10	1055	0,65	0,33	1	522	404	R449A
CVPE-9-13	1305	0,82	0,43	2	635	1009	R449A
CVPE-9-15	1525	0,97	0,49	2	817	1079	R449A
CVPE-9-20	2025	1,31	0,67	3	817	1103	R449A
CVPE-9-25	2525	1,65	0,84	4	1096	1365	R449A
CVPE-9-30	2995	1,96	1,19	4	1315	1416	R449A





características técnicas y constructivas sujetas a variación sin previo aviso

we reserve the right to change specifications whitout prior notice

SERVE OVER COUNTER • VITRINAS MODULARES

- Diseño especial para pastelería, con dos estantes en el plano de exposición y dos puntos de iluminación LED 6500 K estándar
  - Exterior e interior en chapa de acero plastificada
  - Plano exposición y encimera en acero inox AISI-304
  - Bandejas plano de exposición lisas
  - Costados de 40 mm en ABS inyectado excepto acabado madera
  - **Decoración estándar:** costados cortos gris oscuro frontal gris + franja decorativa azul. Perfilería en aluminio anodizado
  - Paragolpes en la parte delantera
  - Cristal frontal templado, abatible
  - Estantes de cristal intermedios, no refrigerados
  - Iluminación LED 6500 K estándar: encimera superior, estante inferior y base frontal
  - Opción LED 3000 K (luz cálida) o ROSA, al mismo precio
  - Aislamiento de poliuretano inyectado, densidad 40 Kg/m<sup>3</sup>, cero efectos ODP y GWP
  - Reserva refrigerada con puertas, hueco 440x270 (excepto modelo neutro)
  - **Evaporador estático, opcional ventilado**, con tratamiento EPOXY anticorrosión de serie
  - Condensación ventilada, evaporación automática de serie (sólo con motor incorporado)
  - Control electrónico de temperatura
  - Indicador de temperatura
  - Descarche automático
  - Clase climática 4 ( 30°C 55%) régimen M1
- M1 temperatura producto -1/+5°C UNE-EN ISO 23953-2:2006

- Design focused for bakery, with two shelves at the exposure and two standard lighting
  - Interior and exterior finish in plastic coated steel
  - Display area and counter in stainless steel AISI-304
  - Smooth deck for display area
  - 40 mm sides in injected ABS, except wood decor
  - **Standard decoration:** short dark gray sides gray front+ blue decorative stripe. Anodised aluminium profiles
  - Front rubber bumper
  - Tempered and hinged front glass
  - Glass shelves non refrigerated
  - Standard LED 6500 K lighting: top worktop, shelf and front base
  - Optional 3000 K LED (soft light) or Fresh red, same price
  - 40 Kg/m<sup>3</sup> density polyurethane insulation, zero ODP and GWP
  - Refrigerated under storage with doors 440x270 (except for ambient models)
  - **Static evaporator, ventilated on demand**, with anticorrosion EPOXY treated as standard
  - Ventilated condensation and automatic evaporation as standard (only models with condenser unit)
  - Electronic temperature controller
  - External thermometer
  - Auto defrost, by heated cable as optional
  - Climate class 4 ( 30°C 55%) regime M1
- M1 product temperature -1/+5°C UNE-EN ISO 23953-2:2006

OPCIONES OPTIONS	decoración frontal front decor	decoración total total decor	lacado alto brillo High glossy lacquered	evaporador ventilado ventilated evaporator	cierre plexi plexi doors	cierre cortina night blind	estante chasis chasis base	luz extra LED extra lighting	neutra neutral	pre-inst.
CV-10										
CV-13										
CV-15										
CV-20										
CV-25										
CV-30										

Versión REMOTO, incluye válvula de expansión (R449A) y valvula solenoide  
REMOTE version, expansion valve (R449A) and solenoid valve, included

220v 60Hz / 115v 60Hz consultar - consult

Vitrina expositora modular serie 9 PASTELERÍA con reserva  
 Serve over counter modular line 9 PASTRY with cold storage

7

all photos must be considered as a reference - fotografías no contractuales



Consultar  
 Consult

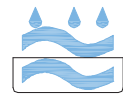

DE SERIE  
 STANDAR



CVEP-9-20-C  
 lacado  
 lacquered



CVEP-9-20-CC  
 madera  
 wood



decoración frontal  
 front decor



versión RR

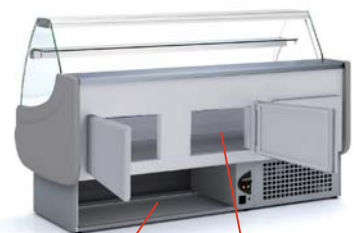

opcional interior 440x270